

YDS-D3MA-IMX258 V1.0

13MP Sony IMX258 MIPI Interface Auto Focus Camera Module



Front View



Back View

Specifications

Camera Module No.	YDS-D3MA-IMX258 V1.0
Resolution	13MP
Image Sensor	IMX258
Sensor Type	1/3.06"
Pixel Size	1.12 um x 1.12 um
EFL	3.81 mm
F.NO	2.20
Pixel	4224 x 3136
View Angle	74.4°(DFOV) 62.7°(HFOV) 48.7°(VFOV)
Lens Dimensions	8.50 x 8.50 x 5.37 mm
Module Size	20.85 x 8.50 mm
Module Type	Auto Focus
Interface	MIPI
Auto Focus VCM Driver IC	DW9763
Lens Model	YDS-LENS-50013A1
Lens Type	650nm IR Cut
Operating Temperature	-20°C to +70°C
Mating Connector	BBR43-30KB533



YDS-D3MA-IMX258 V1.0

13MP Sony IMX258 MIPI Interface Auto Focus Camera Module

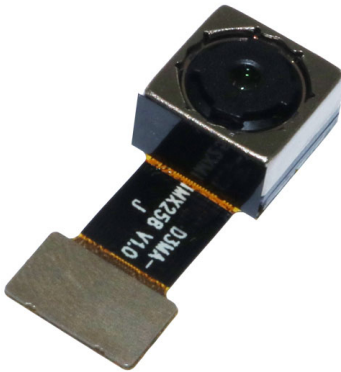

Top View



Side View

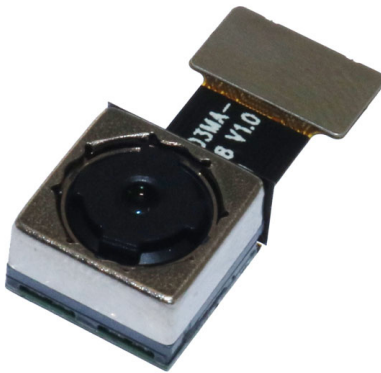

Bottom View

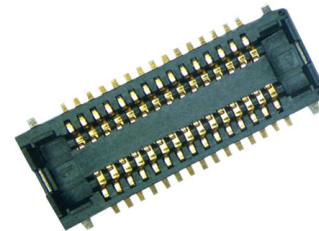

Mating Connector

D		E	
Version	Information	Date	
V1.0	First Version	5-23-2022	

A	
RoHS	
0	SIGNAL
1	GND
2	GND
3	GND
4	GND
5	AFVDD2.8V
6	AFEN
7	SDA
8	DOVDD1.8V
9	SCL
10	DVDD1.2V
11	GND
12	XSHUTDOWN
13	MCN
14	NC
15	MCP
16	GND
17	MD0N
18	MCLK
19	MD0P
20	GND
21	MD1N
22	FLASH
23	MD1P
24	AVDD2.8V
25	VPP(NG)
26	AGND
27	MD2N
28	MD3N
29	MD2P
30	MD3P

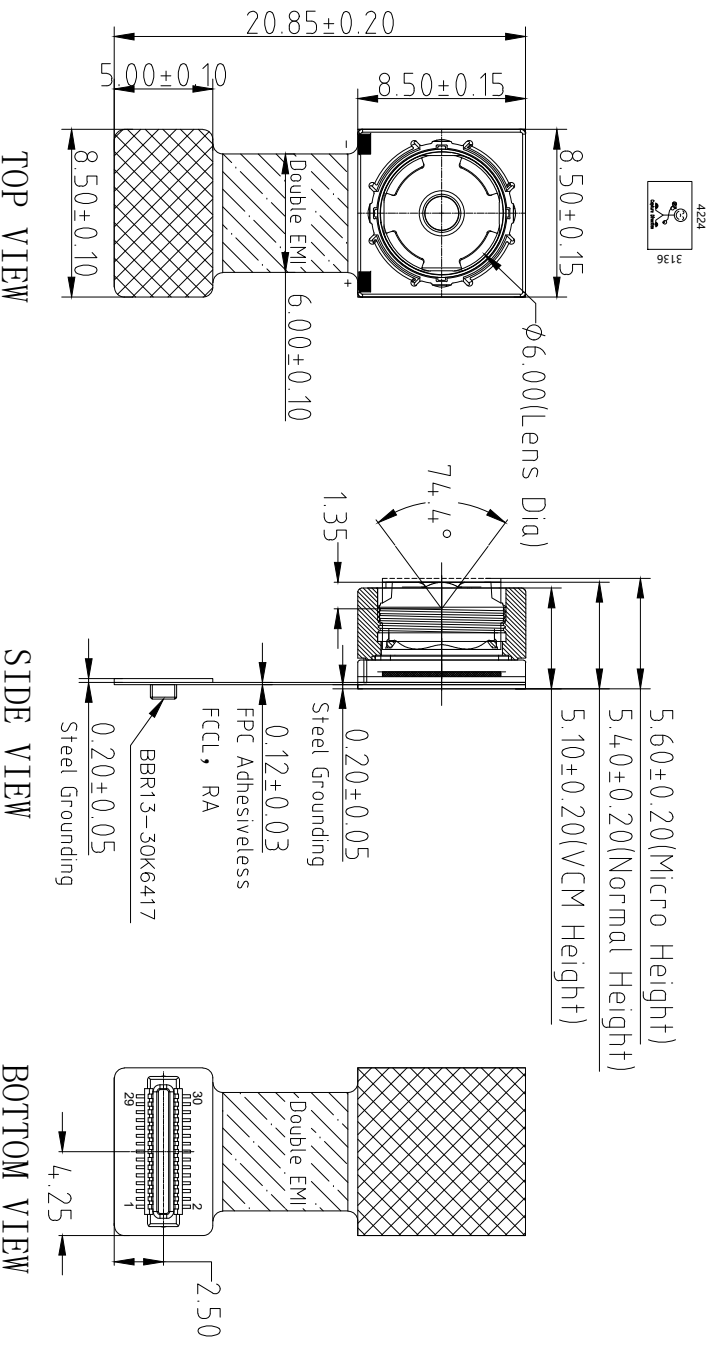

NOTE:
 1.The device slave address:0x34;
 2.Driver IC and its I2C Address:
 DW9763; 0x18h;

Parameters:

1、Sensor specification:

Image Sensor: IMX258
 Pixel: 1.12umx1.12um
 Lens Type: 1/3.06
 Important Voltage Description: DVDD1.2V
 (external power supply);

2、Lens specification:

FOV: 74.4°(D);62.7°(H);48.7°(V);
 F/NO.: 2.2
 TV distortion: <1.5%
 Focal length: 3.85mm
 Composition: 5P+IR FILTER
 IR Cut Coating: 650nm±10nm@50%

Designed By		Kevin		Model Name:		D3MA-IMX258 V1.0	
Checked By		Aouly_Yan		Projection Type:		Unit: mm	
				Third Angle		Scale: 1:1	
				Sheet:		1 of 1	
				Version:		1/0	

[Product Brief]

Ver.1.0

IMX258

Diagonal 5.867 mm (Type 1/3.06) 13Mega-Pixel CMOS Image Sensor with Square Pixel for Color Cameras

Description

IMX258 is a diagonal 5.867mm (Type 1/3.06) 13 Mega-pixel CMOS active pixel type stacked image sensor with a square pixel array. It adopts Exmor R^{STM} technology to achieve high speed image capturing by column parallel A/D converter circuits and high sensitivity and low noise image (comparing with conventional CMOS image sensor) through the backside illuminated imaging pixel structure. R, G, and B pigment primary color mosaic filter is employed. By introducing spatially multiplexed exposure technology, high dynamic range still pictures and movies are achievable. It

equips an electronic shutter with variable integration time. It operates with three power supply voltages: analog 2.7 V, digital 1.2 V and 1.8 V for input/output interface and achieves low power consumption.

In addition, this product is designed for use in cellular phone and tablet pc. When using this for another application, Sony does not guarantee the quality and reliability of product. Therefore, don't use this for applications other than cellular phone and tablet pc. Consult your Sony sales representative if you have any questions.

Functions and Features

- ◆ Back-illuminated and stacked CMOS image sensor Exmor R^{STM}
- ◆ Phase Detection pixel data output for Phase Detection Auto Focus
- ◆ High Dynamic Range (HDR) mode with raw data output.
- ◆ High signal to noise ratio (SNR).
- ◆ Full resolution @30fps (Normal / HDR). 4K2K @30fps (Normal / HDR) 1080p @60fps (Normal)
- ◆ Output video format of RAW10/8.
- ◆ Pixel binning readout and V sub-sampling function.
- ◆ Independent flipping and mirroring.
- ◆ CSI-2 serial data output (MIPI 2lane/4lane, Max. 1.3Gbps/lane, D-PHY spec. ver. 1.1 compliant)
- ◆ 2-wire serial communication.
- ◆ Two PLLs for independent clock generation for pixel control and data output interface.
- ◆ Dynamic Defect Pixel Correction.
- ◆ Fast mode transition. (on the fly)
- ◆ Dual sensor synchronization operation.
- ◆ 4K bit of OTP ROM for users.
- ◆ Built-in temperature sensor.

Device Structure

- ◆ CMOS image sensor
- ◆ Image size : Diagonal 5.867 mm (Type 1/3.06)
- ◆ Total number of pixels : 4224 (H) × 3192 (V) approx. 13.48 M pixels
- ◆ Number of effective pixels : 4224 (H) × 3144 (V) approx. 13.28 M pixels
- ◆ Number of active pixels : 4208 (H) × 3120 (V) approx. 13.13 M pixels
- ◆ Chip size : 5.990 mm (H) × 3.908 mm (V)
- ◆ Unit cell size : 1.12 μm (H) × 1.12 μm (V)
- ◆ Substrate material : Silicon

System block diagram

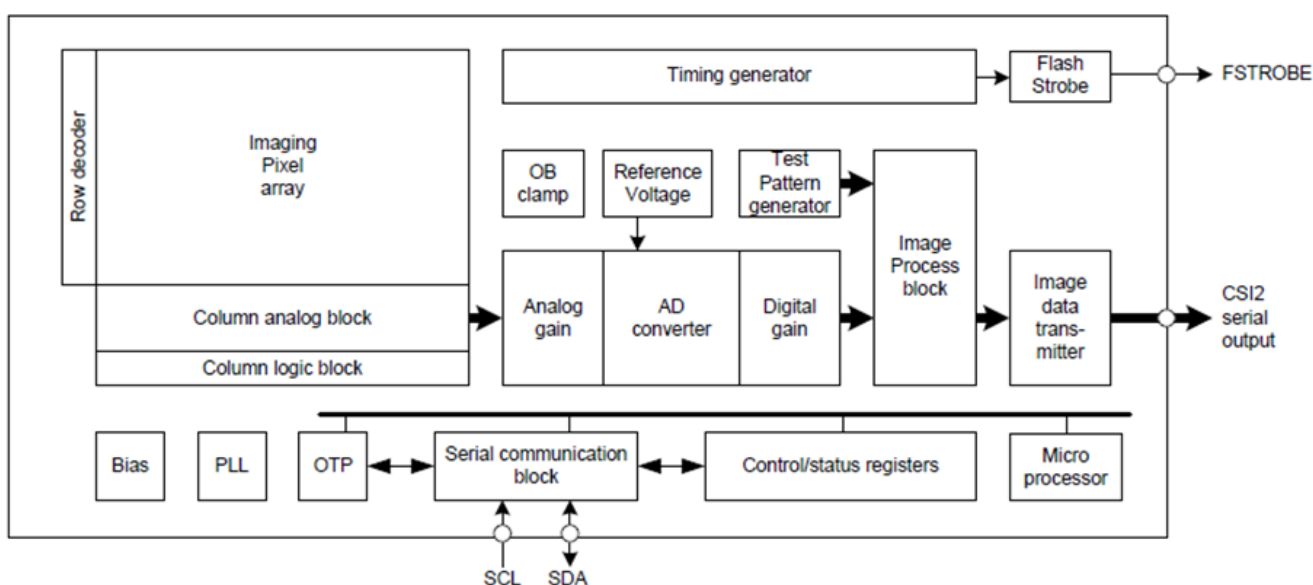

Exmor RS

* Exmor RS is a trademark of Sony Corporation. The Exmor RS is a Sony's CMOS image sensor with high-resolution, high-performance and compact size by replacing a supporting substrate in Exmor R™ which changed fundamental structure of Exmor™ pixel adopted column parallel A/D converter to back-illuminated type, with layered chips formed signal processing circuits.

1. General Description

The DW9763 is a single 10-bit DAC with 100mA output current sinking capability and embedded 8KByte eFlash memory. Designed for linear control of voice coil motors, the DW9763 is capable of operating voltage up to 3.3V.

The SAC (Smart Actuator Control) mode is applied to minimize the mechanical vibration. The SAC mode highly improves the actuator's settling time and tolerance coverage compared with conventional LSC (Linear Slope Control) mode. The DAC and eFlash are controlled via an I2C compatible serial interface.

The DW9763 incorporates with a POR (Power On Reset) circuit, power down mode. POR circuit gets to operate when VDD (supply power) turns on. The output current keeps 0mA until valid register value takes place. During the power down mode, it consumes current max.1uA.

The DW9763 is designed for auto focus and optical zoom for mobile camera, digital still camera, camcorders and other nano actuator applications.

■ Features

- 10 bit resolution current sinking of 100mA for VCM
- SAC (Smart Actuator Control) mode
- Supply voltage range (VDD) : 2.3V to 3.3V
- Fast mode I2C interface compatible (1.8V interface available)
- Power down mode
- Power on reset (POR)
- Embedded 8KByte eFlash memory
- Package : 8 pin WLCSP
- Package Size : 0.77mm X 1.75mm X 0.3mm

■ Applications

- Mobile camera
- Digital still camera
- Camcorder
- Web camera
- Nano actuator

YDS-LENS-50013A1

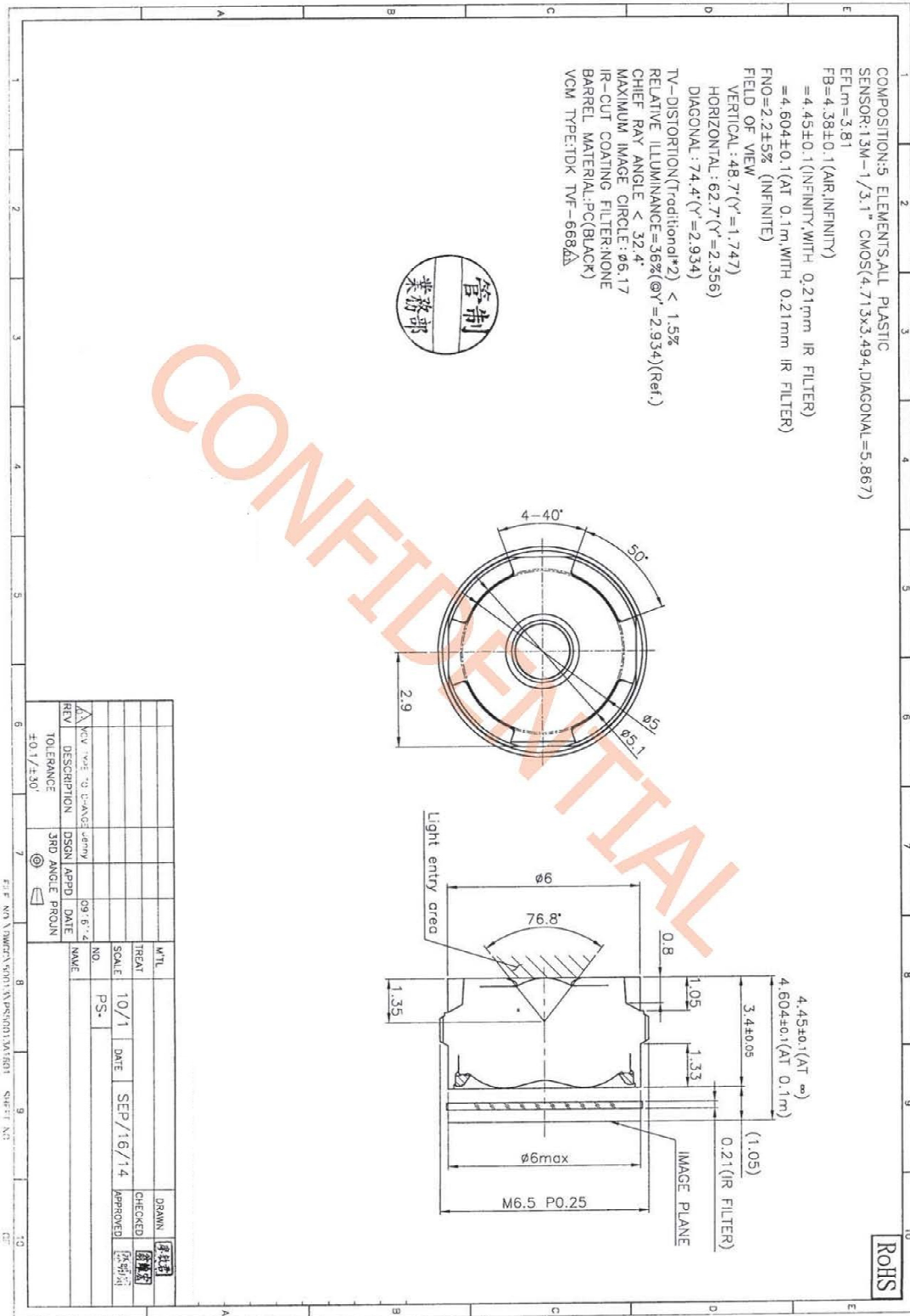

1 2 3 4 5 6 7 8

REV.	EC#	DESCRIPTION	DATE	DRAWN	CHECKED	APPROVED
A	TJECR10018-02	NEW RELEASE PER NPRI 0009	11/05/10	RAIN	DICK, SON	HARDWARE
B	TJECR13014	AXI, AXI	05/13/13	RAIN	SteveM	Jeff

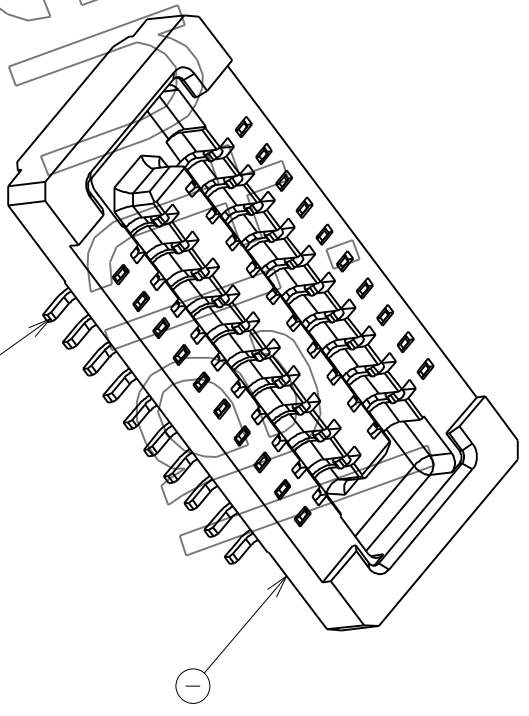
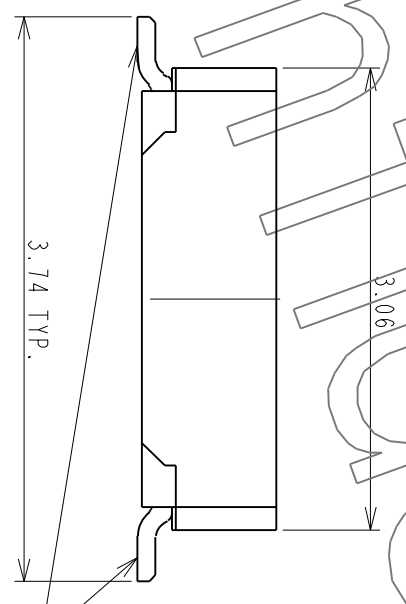
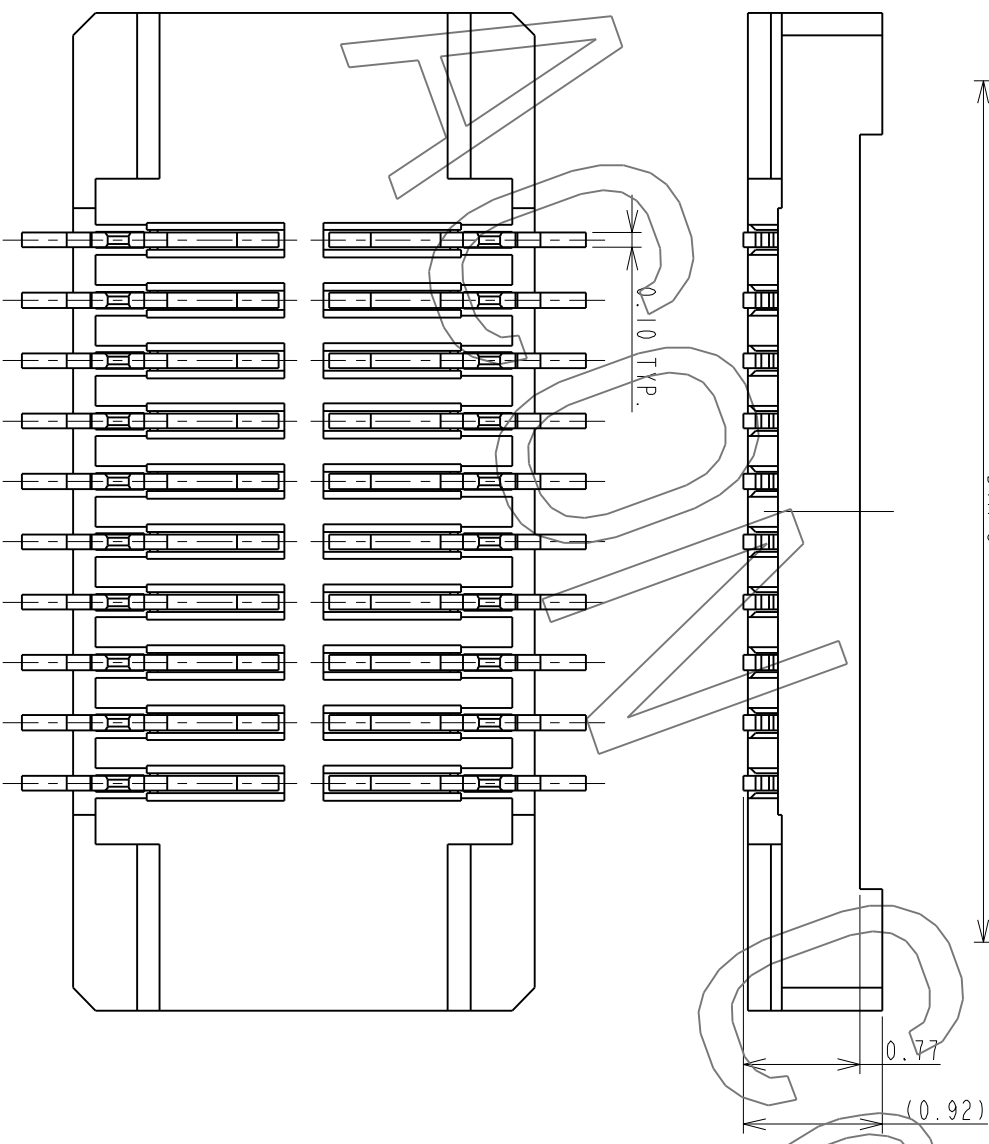
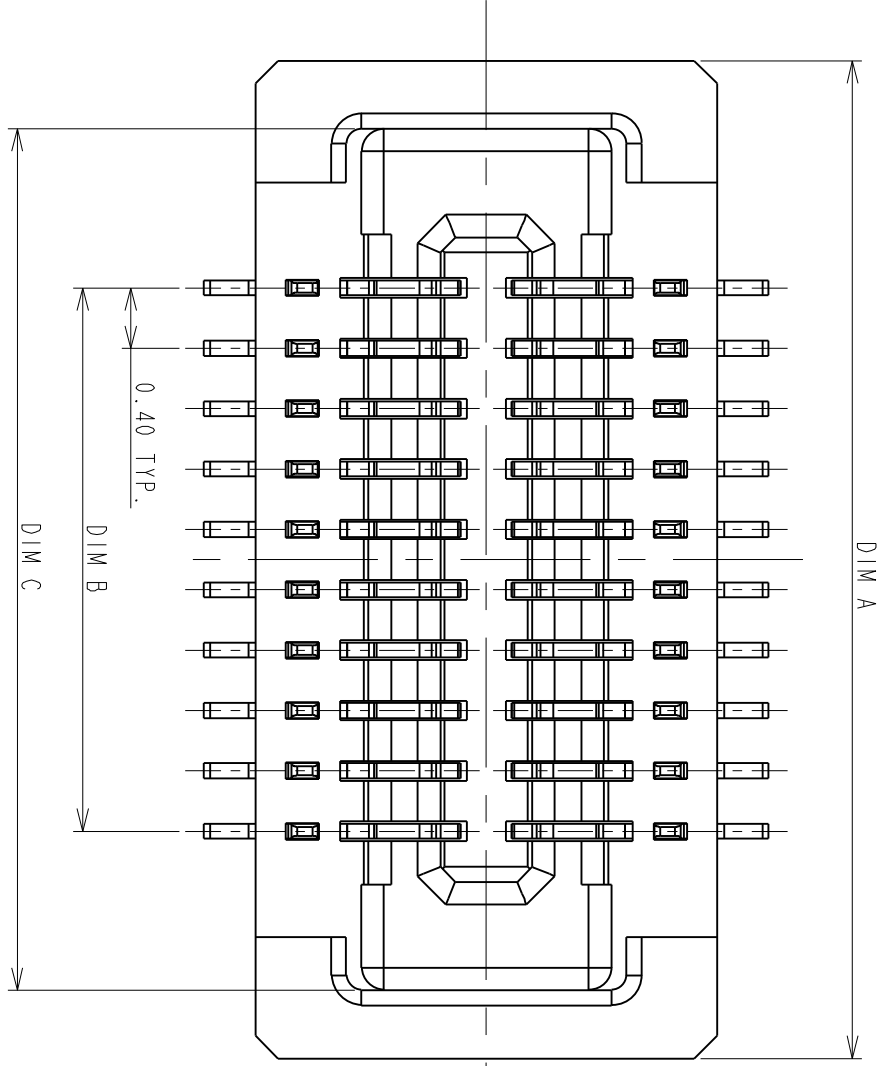

0.08
ALL OF PLACES

ITEM	NAME	Q'TY	PART #	MATERIAL / FINISH
2	CONTACT	XX	T-BBR43-100X30	COPPER ALLOY/PLATING GOLD
1	HOUSING	1	I-BBR43-1XXX33	HIGH TEMP RESIN/UL 94 V-0

TOLERANCES UNLESS OTHERWISE SPECIFIED	
GENERAL	.XX ±0.38
DESIGN	.XXX ±0.25
RAIN	04/15/10
CHECKED	DATE
HARDWARE	04/24/10
APPROVED	DATE
DICK, LEE	04/24/10

SCALE	TITLE
20:1	P0.4#11.0mm BOARD TO BOARD CONN. RECEPTACLE WITHOUT HOLD DOWN
SHEET 1 OF 2	
UNIT	
MM	
CUSTOMER DRAWING	
DWG NO.	C-BBR43-04-01
REV.	B



This document and information contained herein are the property of Advanced Connectek Inc. Copies are issued in strict confidence and shall not be reproduced or copied, or used as the basis of manufacture or sale of apparatus without permission.

All materials meet the ACON's spec. environment-related substances management technical standard

F E D C B A

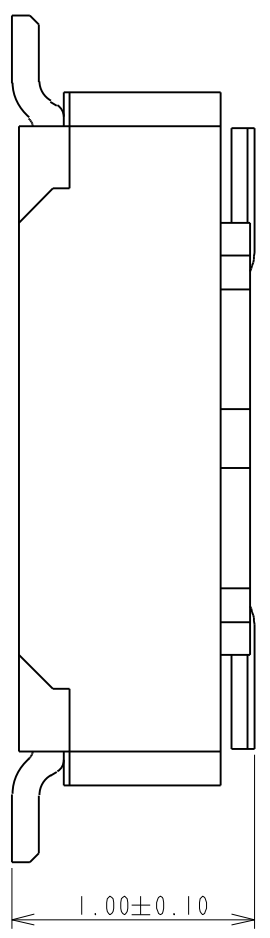

PRODUCT NUMBERING CODE:
 BBR43 - XX K X 5 X X
 1 2 3 4 5 6 7

1. PRODUCTION CODE:
 BBR43: BOARD TO BOARD 0.4 PITCH RECEPTACLE

2. POSITIONS:
 XX: POSITIONS(SEE TABLE A)

3. INSULATOR COLOR:
 K: BLACK

4. CONTACT PLATING:
 1: GOLD 10u" MIN
 2: GOLD 5u" MIN
 3: GOLD 10u" MIN
 B: GOLD 4u" MIN FOR SPOT PLATING
 ALL OVER: NI 50~100u"

5. TYPE OF HEIGHT:
 5: H=0.77mm

6. TYPE OF HOLD DOWN:
 3: WITHOUT HOLD DOWN

7. OTHER
 2: WITH POST, FINISHED PRODUCTS
 3: WITHOUT POST, FINISHED PRODUCTS

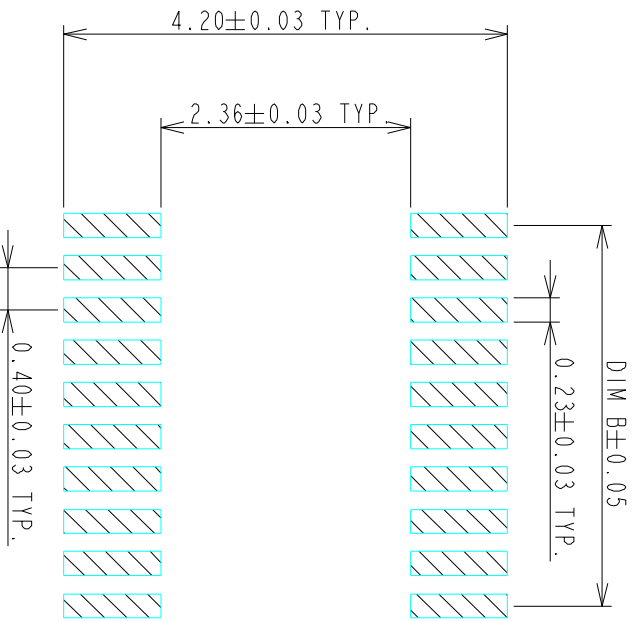

RECOMMENDED P.C. BOARD PATTERN DIMENSION (WITHOUT HOLD DOWN)

NOTES:
 1.0: RATING
 1.1: VOLTAGE: 60V AC/DC
 1.2: CURRENT: 0.5 AMPS
 1.3: OPERATION TEMPERATURE: -40°C TO +85°C
 2.0: ELECTRICAL CHARACTERISTIC:
 2.1: CONTACT RESISTANCE: 50 mΩ MAX INITIAL
 2.2: INSULATION RESISTANCE: 1000 MΩ MIN INITIAL
 2.3: DIELECTRIC WITHSTANDING VOLTAGE: 250V AC FOR ONE MINUTE
 3.0 TOLERANCES UNLESS OTHERWISE SPECIFIED
 GENERAL: DIMENSION >10.00 ±0.13
 DIMENSION 5.00~10.00 ±0.10
 DIMENSION <5.00 ±0.05

4.0 ALL COPPLANARITY IS 0.08mm MAX. BEFORE REFLOW
ALL COPPLANARITY IS 0.10mm MAX. AFTER REFLOW

TABLE A:

POSITIONS	DIM A	DIM B	DIM C
10	4.61	1.60	3.71
14	5.41	2.40	4.51
16	5.81	2.80	4.91
18	6.21	3.20	5.31
20	6.61	3.60	5.71
22	7.01	4.00	6.11
24	7.41	4.40	6.51
26	7.81	4.80	6.91
30	8.61	5.60	7.71
32	9.01	6.00	8.11
34	9.41	6.40	8.51
40	10.61	7.60	9.71
44	11.41	8.4	10.51
48	12.21	9.20	11.31
50	12.61	9.60	11.71
54	13.41	10.40	12.51
60	14.61	11.60	13.71
70	16.61	13.60	15.71
80	18.61	15.60	17.71

TOLERANCES UNLESS OTHERWISE SPECIFIED		DRAWN		DATE	
GENERAL X	±0.38	RAIN	04/15/10		
XX	±0.13	DESIGN			
ANGLES X°	±3.0°	RAIN	04/15/10		
SCALE	20:1	CHECKED			
SHEET	2 OF 2	HARDWARE	04/24/10		
UNIT	MM	APPROVED			
		DICK. LEE	04/24/10		
		CUSTOMER DRAWING		TITLE	
				P0.4*H1.0mm BOARD TO BOARD	
				CONN. RECEPTACLE	
				WITHOUT HOLD DOWN	
		SERIES		SIZE	
		BBR		A3	
		DWG NO. C-BBR43-04-01		REV. B	



YDS CAMERA MODULE

your best camera partner

Camera Module Pinout Definition Reference Chart

OmniVision	Sony	Samsung	On-Semi	Aptina	Himax	GalaxyCore	PixArt	SmartSens	Sensors
Pin Signal		Description							
DGND	GND								ground for digital circuit
AGND									ground for analog circuit
PCLK	DCK								DVP PCLK output
XCLR	PWDN	XSHUTDOWN	STANDBY						power down active high with internal pull-down resistor
MCLK	XVCLK	XCLK	INCK						system input clock
RESET	RST								reset active low with internal pull-up resistor
NC	NULL								no connect
SDA	SIO_D	SIOD							SCCB data
SCL	SIO_C	SIOC							SCCB input clock
VSYNC	XVS	FSYNC							DVP VSYNC output
HREF	XHS								DVP HREF output
DOVDD									power for I/O circuit
AFVDD									power for VCM circuit
AVDD									power for analog circuit
DVDD									power for digital circuit
STROBE	FSTROBE								strobe output
FSIN									synchronize the VSYNC signal from the other sensor
SID									SCCB last bit ID input
ILPWM									mechanical shutter output indicator
FREX									frame exposure / mechanical shutter
GPIO									general purpose inputs
SLASEL									I2C slave address select
AFEN									CEN chip enable active high on VCM driver IC
MIPI Interface									
MDN0	DN0	MD0N	DATA_N	DMO1N					MIPI 1st data lane negative output
MDP0	DP0	MD0P	DATA_P	DMO1P					MIPI 1st data lane positive output
MDN1	DN1	MD1N	DATA2_N	DMO2N					MIPI 2nd data lane negative output
MDP1	DP1	MD1P	DATA2_P	DMO2P					MIPI 2nd data lane positive output
MDN2	DN2	MD2N	DATA3_N	DMO3N					MIPI 3rd data lane negative output
MDP2	DP2	MD2P	DATA3_P	DMO3P					MIPI 3rd data lane positive output
MDN3	DN3	MD3N	DATA4_N	DMO4N					MIPI 4th data lane negative output
MDP3	DP3	MD3P	DATA4_P	DMO4P					MIPI 4th data lane positive output
MCN	CLKN	CLK_N	DCKN						MIPI clock negative output
MCP	CLKP	MCP	CLK_P	DCKN					MIPI clock positive output
DVP Parallel Interface									
D0	DO0	Y0							DVP data output port 0
D1	DO1	Y1							DVP data output port 1
D2	DO2	Y2							DVP data output port 2
D3	DO3	Y3							DVP data output port 3
D4	DO4	Y4							DVP data output port 4
D5	DO5	Y5							DVP data output port 5
D6	DO6	Y6							DVP data output port 6
D7	DO7	Y7							DVP data output port 7
D8	DO8	Y8							DVP data output port 8
D9	DO9	Y9							DVP data output port 9
D10	DO10	Y10							DVP data output port 10
D11	DO11	Y11							DVP data output port 11

www.YDSCAM.com sales@ydscam.com Phone (WeChat, QQ): (+86) 177 2732 6718

All rights reserved @ YingDeShun Co. Ltd. Specifications subject to change without notice.

Cameras Applications



IMAGING DEVICES



Camera Reliability Test

Reliability Inspection Item		Testing Method	Acceptance Criteria	
Category	Item			
Environmental	Storage Temperature	High 60°C 96 Hours	Temperature Chamber	No Abnormal Situation
		Low -20°C 96 Hours	Temperature Chamber	No Abnormal Situation
	Operation Temperature	High 60°C 24 Hours	Temperature Chamber	No Abnormal Situation
		Low -20°C 24 Hours	Temperature Chamber	No Abnormal Situation
	Humidity	60°C 80% 24 Hours	Temperature Chamber	No Abnormal Situation
	Thermal Shock	High 60°C 0.5 Hours Low -20°C 0.5 Hours Cycling in 24 Hours	Temperature Chamber	No Abnormal Situation
Physical	Drop Test (Free Falling)	Without Package 60cm	10 Times on Wood Floor	Electrically Functional
		With Package 60cm	10 Times on Wood Floor	Electrically Functional
	Vibration Test	50Hz X-Axis 2mm 30min	Vibration Table	Electrically Functional
		50Hz Y-Axis 2mm 30min	Vibration Table	Electrically Functional
		50Hz Z-Axis 2mm 30min	Vibration Table	Electrically Functional
	Cable Tensile Strength Test	Loading Weight 4 kg 60 Seconds Cycling in 24 Hours	Tensile Testing Machine	Electrically Functional
Electrical	ESD Test	Contact Discharge 2 KV	ESD Testing Machine	Electrically Functional
		Air Discharge 4 KV	ESD Testing Machine	Electrically Functional
	Aging Test	On/Off 30 Seconds Cycling in 24 Hours	Power Switch	Electrically Functional
	USB Connector	On/Off 250 Times	Plug and Unplug	Electrically Functional



Camera Inspection Standard

Inspection Item		Inspection Method	Standard of Inspection		
Category	Item				
Appearance	FPC/ PCB	Color	The Naked Eye	Major Difference is Not Allowed.	
		Be Torn/Chopped	The Naked Eye	Copper Crack Exposure is Not Allowed.	
		Marking	The Naked Eye	Clear, Recognizable (Within 30cm Distance)	
	Holder	Scratches	The Naked Eye	The Inside Crack Exposure is Not Allowed	
		Gap	The Naked Eye	Meet the Height Standard	
		Screw	The Naked Eye	Make Sure Screws Are Presented (If Any)	
		Damage	The Naked Eye	The Inside Crack Exposure is Not Allowed	
	Lens	Scratch	The Naked Eye	No Effect On Resolution Standard	
		Contamination	The Naked Eye	No Effect On Resolution Standard	
		Oil Film	The Naked Eye	No Effect On Resolution Standard	
		Cover Tape	The Naked Eye	No Issue On Appearance.	
	Function	Image	No Communication	Test Board	Not Allowed
			Bright Pixel	Black Board	Not Allowed In the Image Center
Dark Pixel			White board	Not Allowed In the Image Center	
Blurry			The Naked Eye	Not Allowed	
No Image			The Naked Eye	Not Allowed	
Vertical Line			The Naked Eye	Not Allowed	
Horizontal Line			The Naked Eye	Not Allowed	
Light Leakage			The Naked Eye	Not Allowed	
Blinking Image			The Naked Eye	Not Allowed	
Bruise			Inspection Jig	Not Allowed	
Resolution			Chart	Follows Outgoing Inspection Chart Standard	
Color			The Naked Eye	No Issue	
Noise			The Naked Eye	Not Allowed	
Corner Dark			The Naked Eye	Less Than 100px By 100px	
Color Resolution			The Naked Eye	No Issue	
Dimension	Height	The Naked Eye	Follows Approval Data Sheet		
	Width	The Naked Eye	Follows Approval Data Sheet		
	Length	The Naked Eye	Follows Approval Data Sheet		
	Overall	The Naked Eye	Follows Approval Data Sheet		

YDSCAM Package Solutions

YDS Camera Module



Complete with Lens Protection Film



Tray with Grid and Space



Place Cameras on the Tray



YDSCAM Package Solutions

Full Tray of Cameras



Cover Tray with Lid



Place Tray into Anti-Static Bag



Vacuum the Anti-Static Bag



YDSCAM Package Solutions

Sealed Vacuum Anti-Static Bag with Labels

1. Model and Description 2. Quantity 3. Manufacturing Date Code 4. Caution



YDSCAM Package Solutions

Place Foam Sheets Between Tray Bags



Foam Sheets are Larger Than Trays



Place Foam Sheets and Trays into Box



Foam Sheets are Tightly Fitting in Box



Seal the Carbon Box



Label the Carbon Shipping Box





YDSCAM Package Solutions

USB Camera Module

Complete with Lens Protection Film

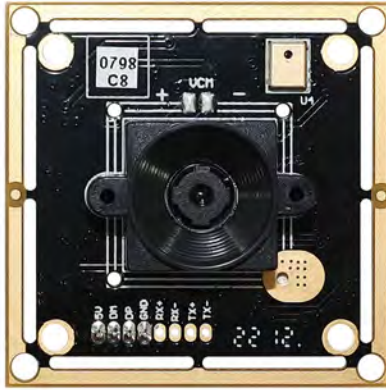

Place Camera Sample into Anti-Static Bag

Place USB Cameras into Tray



Seal the Tray with Anti-Static Bag

Label the Carbon Shipping Box



YDSCAM Package Solutions

Place Camera Sample into Anti-Static Bag



Place Connectors into Anti-Static Bag



Label the Sample Bags



Place Connectors into Reel



Place Samples into the Carbon Box



Place Connectors into the Carbon Box





YDS CAMERA MODULE

your best camera partner

Company YDSCAM

YingDeShun Co. Ltd. (YDS) was established in 2017, a next-generation technology driven manufacturer specialized in research, design, and produce of audio and video products. YDS is occupying 20,000 square feet automated plants with 100 employees of annual throughput 30,000,000 units cameras.

YDS provides OEM, ODM design, contract manufacturing, and builds the camera products. You may provide the requirements to us, even with a hand draft, our sales and engineering work together to meet your needs. We consider ourselves your last-term partner in developing practical and innovative solutions.

Our team covers everything from initial concept development to mass produced product. YDS specializes in customized camera design, raw material, electronic engineering, firmware/software development, product testing, and packing design. Our experienced strategic supply systems offer a robust and dependable manufacturing capacity for orders of various sizes.

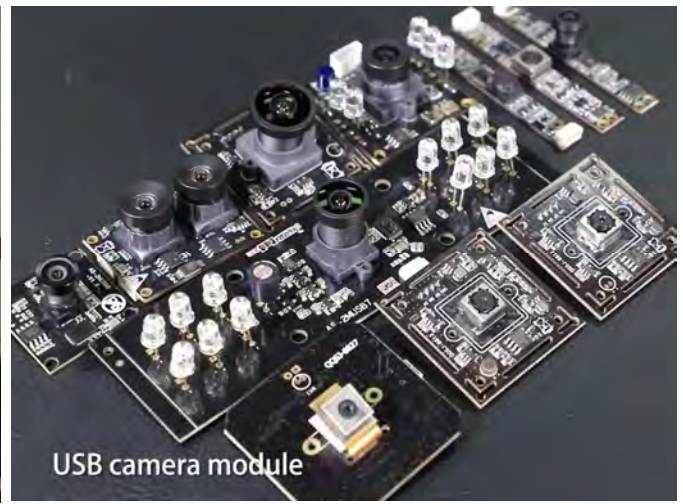

Limited Warranty

YDS provides the following limited warranty if you purchased the Product(s) directly from YDS company or from YDS's website www.YDSCAM.com. Product(s) purchased from other sellers or sources are not covered by this Limited Warranty. YDS guarantees that the Product(s) will be free from defects in materials and workmanship under normal use for a period of one (1) year from the date you receive the product ("Warranty Period").

For all Product(s) that contain or develop material defects in materials or workmanship during the Warranty Period, YDS will, at its sole option, either: (i) repair the Product(s); (ii) replace the Product(s) with a new or refurbished Product(s) (replacement Product(s) being of identical model or functional equivalent); or (iii) provide you a refund of the price you paid for the Product(s).

This Limited Warranty of YDS is solely limited to repair and/or replacement on the terms set forth above. YDS is not reliable or responsible for any subsequent events.



www.YDSCAM.com sales@ydscom.com Phone (WeChat, QQ): (+86) 177 2732 6718

All rights reserved @ YingDeShun Co. Ltd. Specifications subject to change without notice.



YDS CAMERA MODULE

your best camera partner

YDS Strength

Powerful Factory



Professional Service



Promised Delivery



www.YDSCAM.com sales@ydscam.com Phone (WeChat, QQ): (+86) 177 2732 6718

All rights reserved @ YingDeShun Co. Ltd. Specifications subject to change without notice.